



# PRODUCT SPECIFICATION

<b>DOCUMENT NO. ENS000090560</b>				
<b>DESCRIPTION</b>	<b>DRAWN BY</b>	<b>DESIGNED BY</b>	<b>CHECKED BY</b>	<b>APPROVED BY</b>
WIP252012S L Series	Yishan	Yishan	Jiajing	Wiley

RoHS



## WIP252012S L Series Engineering Specification

### 1. Scope

#### Feature

- High saturation current realized by material properties and structure design
- Low DC resistance to achieve high conversion efficiency and lower temperature rising
- Low Profile: 2.5 mm × 2.0 mm × 1.2 mm.
- Magnetically shielded structure to accomplish high resolution in EMC protection.
- Halogen free, Lead Free, RoHS Compliance.
- Surface marking : None.
- The moisture sensitivity level (MSL) of products is level 1.

#### Applications

- Smart phone, PAD
- DC/DC converter
- Thin-type power supply module,

### 2. Explanation of Part Number

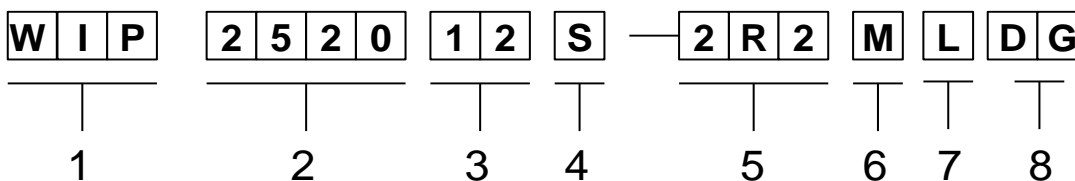

- ◆ 1 : Series Name: Wire-wound type power inductor
- ◆ 2 : Size Code: The first two digitals: length(mm), The last two digitals: width(mm)
- ◆ 3 : Thickness in mm
- ◆ 4 : Type code
- ◆ 5 : Initial inductance value: 2R2 = 2.2  $\mu$ H
- ◆ 6 : Model code, Tolerance of Inductance  $\pm 20\%$ .
- ◆ 7 : Electrode type.
- ◆ 8 : Control code.

### 3. Construction & Dimensions

#### 3.1. End termination: Cu/Ni/Sn

#### 3.2. Construction & Dimension :

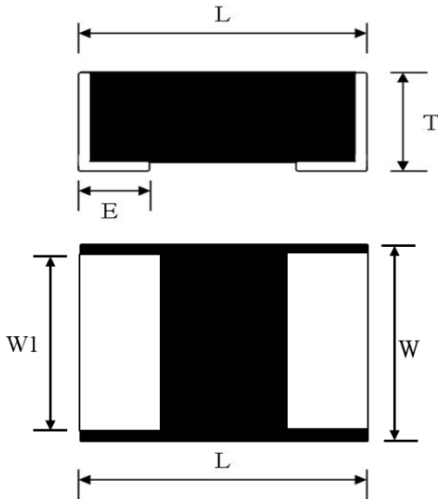

L [mm]	W [mm]	W1 [mm]	T [mm]	E [mm]
2.5±0.2	2.0±0.2	1.8±0.2	1.2 max.	0.6±0.3

#### 3.3. Recommend Land Pattern Dimensions :

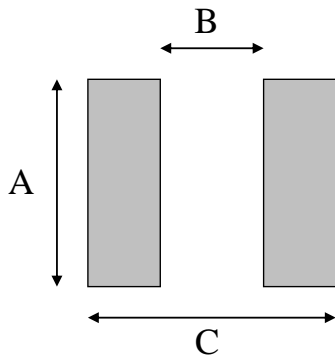

A [mm]	B [mm]	C [mm]
2.0	1.2	2.8

### 4. General specifications

#### 4.1. Temperature Specifications

Operating Temperature range : -40°C to +125°C (including self-temperature rising)  
 Storage Temperature range : -50°C to +125°C

## 5. Performance Characteristics

### 5.1. Specifications

INPAQ Part Number	Li [ $\mu$ H] Initial inductance	RDC [ $m\Omega$ ] DC Resistance		Isat [A] Saturation Current		I <sub>rms</sub> [A] Heat Rating Current		SRF [MHz]	Quality Factor
		Typ.	Max.	Typ.	Max.	Typ.	Max.	Typ.	Typ.
WIP252012S-R47MLDG	0.47	16	22	6.8	6.2	5.8	4.9	>120	30
WIP252012S-1R0MLDG	1	36	44	4.8	4.3	3.9	3.3	70	30
WIP252012S-1R5MLDG	1.5	54	63	4.0	3.5	2.9	2.5	60	30
WIP252012S-2R2MLDG	2.2	74	89	3.5	3.2	2.5	2.2	50	30
WIP252012S-3R3MLDG	3.3	116	130	2.8	2.5	2.1	1.8	40	30
WIP252012S-4R7MLDG	4.7	160	180	2.2	2.0	1.8	1.5	35	30

Note 1: Customized design is available, please contact us.

Note 2: All test referenced to 25°C ambient

Note 3: Inductance tolerance +/- 20%

Note 4: Inductance is measured with Agilent® LCR meter 4285A (or equivalent) at 1MHz/1V.

Note 5: DC resistance is measured with HIOKI® micro-ohm meter RM3542 or equivalent.

Note 6: Isat means that DC current will cause a 30% inductance reduction from initial value.

Note 7: I<sub>rms</sub> means that DC current will cause part temp. rising 40°C whichever is smaller.

Note 8: Withstand voltage is 20V DC

### 5.2. Current Characteristic

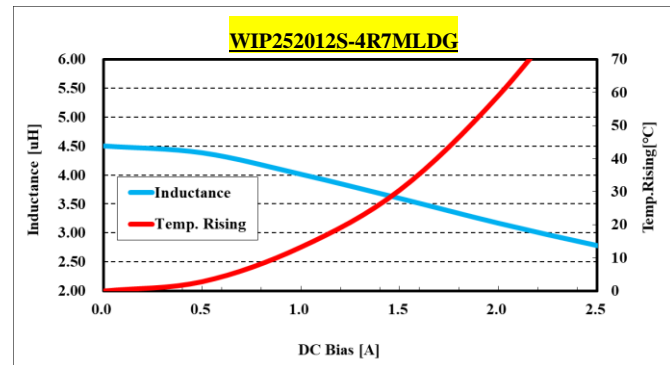
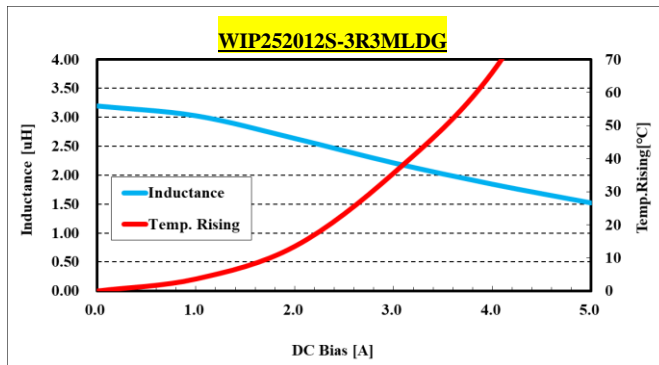
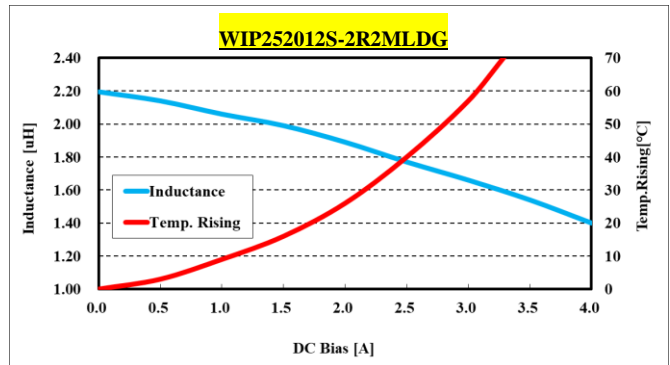
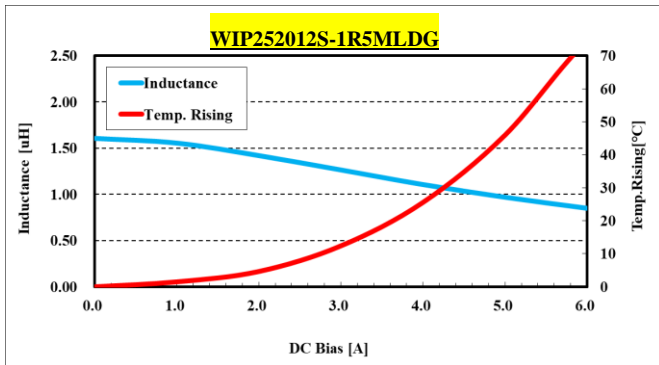
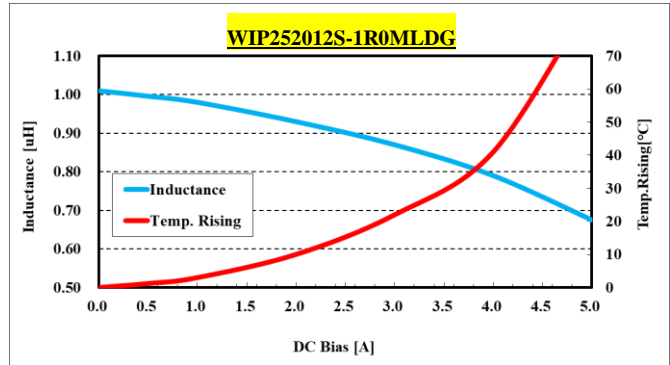
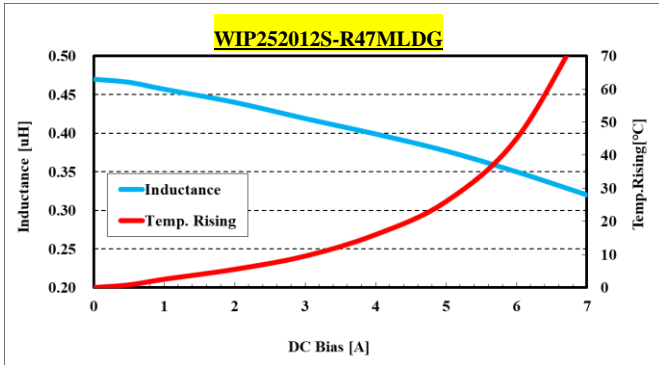

### 5.3. Frequency Characteristic

#### 5.3.1 Inductance & Q factor – Freq. Curve

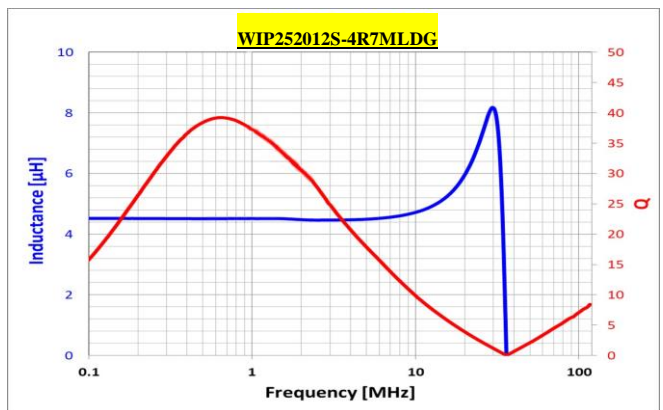
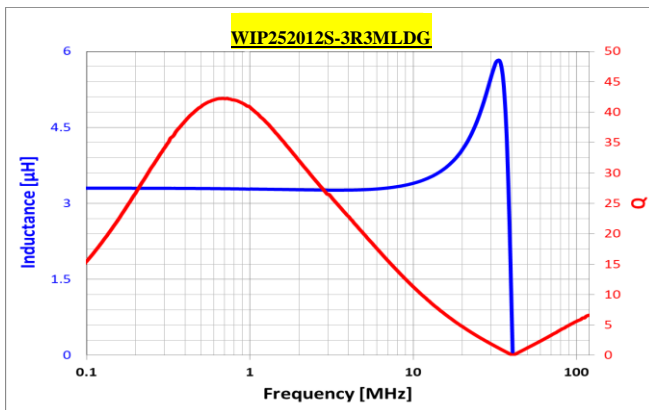
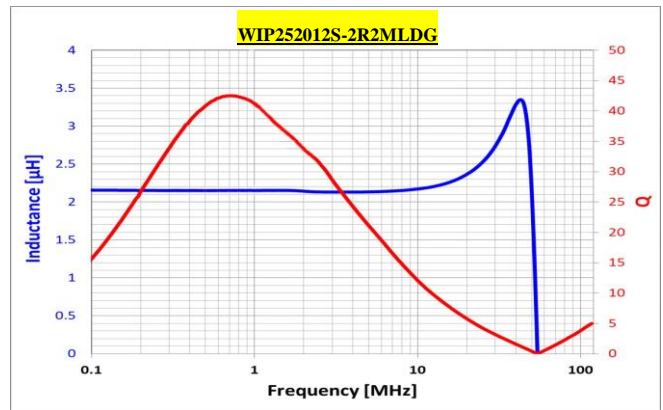
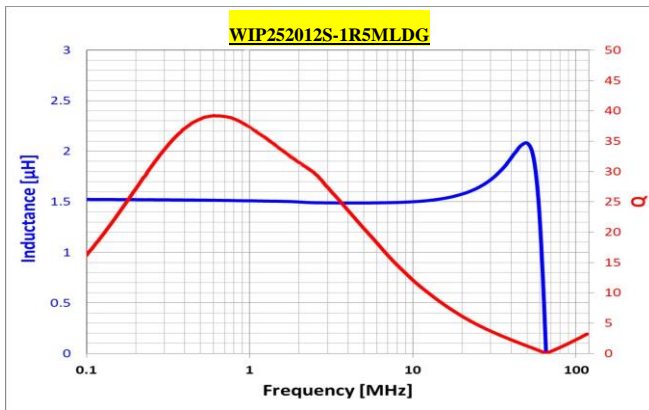
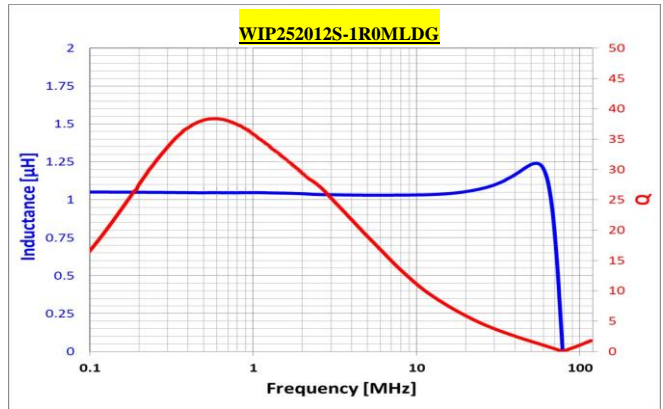
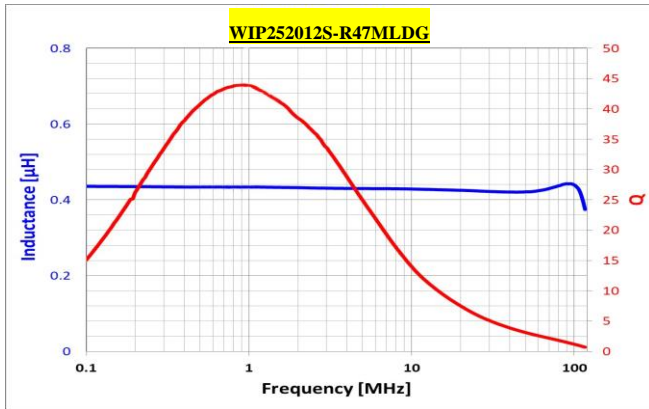

## 6. Reliability and Test Condition

Test item	Test condition	Criteria
<b>Resistance to Solder Heat</b>	1. Solder temperature : $260 \pm 5^{\circ}\text{C}$ 2. Flux : Rosin 3. DIP time : $10 \pm 1$ sec	1. More than 95 % of terminal electrode should be covered with new solder 2. No mechanical damage 3. Inductance value should be within $\pm 20$ % of the initial value
<b>Adhesive Test</b>	1. Reflow temperature : $245^{\circ}\text{C}$ It shall be Soldered on the substrate applying direction parallel to the substrate 2. Apply force(F) : 5 N 3. Test time : 10 sec	1. No mechanical damage 2. Soldering the products on PCB after the pulling test force > 5 N
<b>Temperature Cycle</b>	1. Temperature: $-50 \sim 125^{\circ}\text{C}$ For 30 minutes each 2. Cycle: 500 cycles 3. Measurement: At ambient temperature 24 hours after test completion	1. No mechanical damage 2. Inductance should be within $\pm 20\%$ of the initial value
<b>Dry Heat Test</b>	1. Temperature: $85 \pm 2^{\circ}\text{C}$ 2. Testing time: 500 hrs 3. Applied current: Full rated current 4. Measurement: At ambient temperature 24 hours after test completion	1. No mechanical damage 2. Inductance should be within $\pm 20\%$ of the initial value
<b>Humidity Test</b>	1. Temperature: $60 \pm 2^{\circ}\text{C}$ 2. Humidity: 90-95 % RH 3. Applied current: Full rated current 4. Testing time: 500 hrs 5. Measurement: At ambient temperature 24 hours after test completion	1. No mechanical damage 2. Inductance should be within $\pm 20\%$ of the initial value

## 7. Taping Package and Label Marking

### 7.1. Carrier tape dimensions (Plastic Tape)

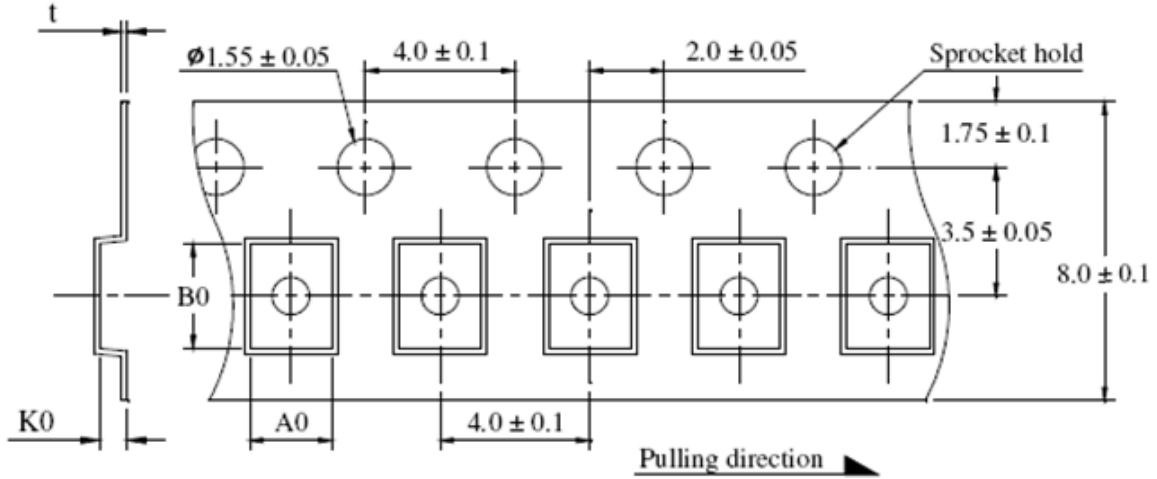

	A0	B0	K0	t
mm	2.25±0.05	2.80±0.1	1.35±0.1	0.22±0.05

### 7.2. Taping reel dimensions

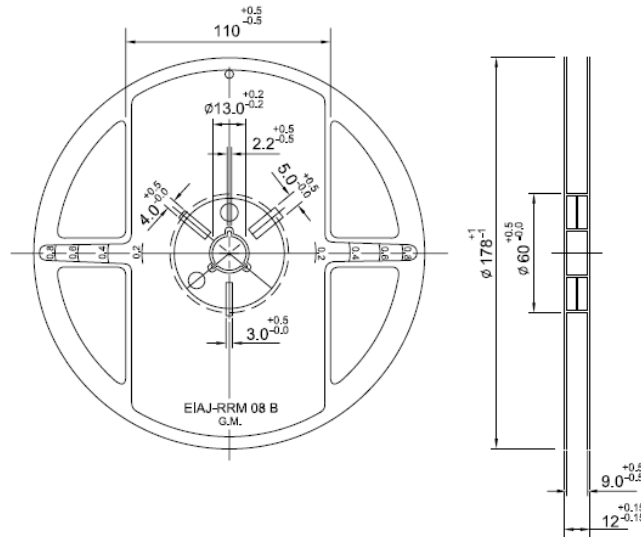

PART SIZE (EIA SIZE)	<b>2520 (1008)</b>
Qty.(pcs)	3,000
BOX	5 reels / inner box



### 7.3. Taping specifications

There shall be the portion having no product in both the head and the end of taping, and there shall be the cover tape in the head of taping.

### 7.4. Label Marking

The label specified as follows shall be put on the side of reel.

(1) Part No.

(2) Quantity

(3) Lot No.

\* Part No. And Quantity shall be marked on outer packaging.

### 7.5. Quantity of products in the taping package

(1) Standard quantity : 3000pcs/Reel

(2) Shipping quantity is a multiple of standard quantity.

## 8. Precautions for Handling

### 8.1. Precaution for handling of substrate

Do not exceed to bend the board after soldering this product extremely.  
(reference examples)

- Mounting place must be as far as possible from the position, which is close to the break line of board, or on the line of large holes of board.
- Do not bend extremely the board, in mounting another components.  
If necessary, use back-up pin (support pin) to prevent from bending extremely.
- Do not break the board by hand. We recommend to use the machine or the jig to break it.

### 8.2. Precaution for soldering

Note that this product will be easily damaged by rapid heating, rapid cooling or local heating.

Do not give heat shock over 100°C in the process of soldering. We recommend to take preheating and gradual cooling.

8.3. Recommendable reflow soldering

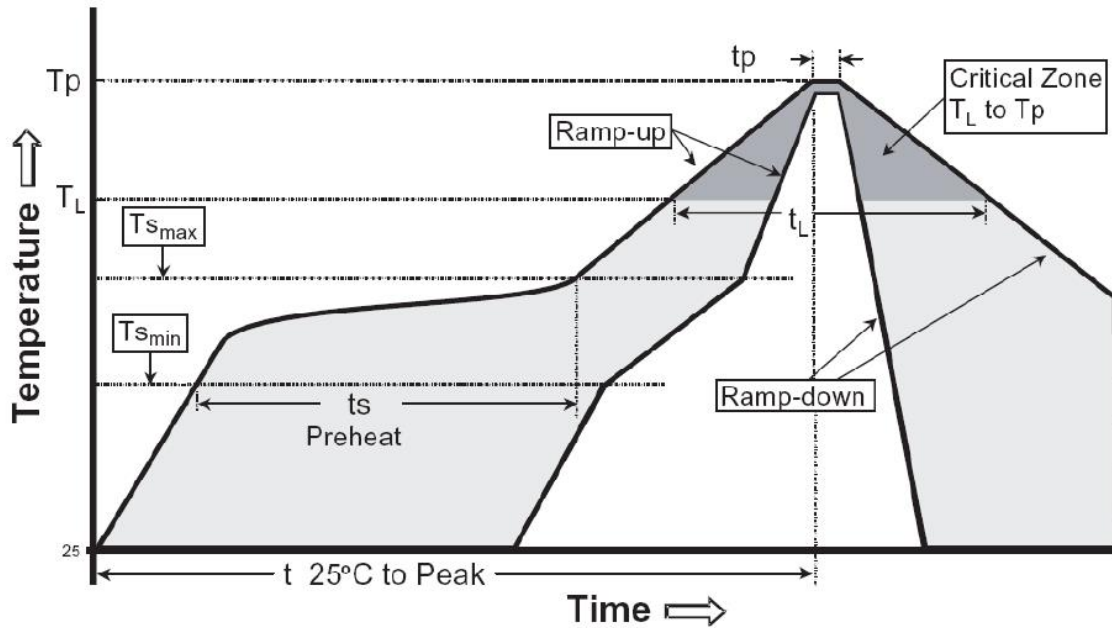

Reference IPC-020c-5-1

Profile Feature	Pb free Assembly
Average Ramp Rate (Ts max to Tp)	3 °C/second max
Preheat	
- Temperature Min (Ts <sub>min</sub> )	150°C
- Temperature Min (Ts <sub>max</sub> )	200°C
- Time(ts <sub>min</sub> to ts <sub>min</sub> )	60-180 seconds
Time maintained above:	
- Temperature (TL)	217°C
- Time (tL)	60-150 seconds
Peak Temperature (Tp)	260°C +0/-5 °C
Time within 5 °C of actual Peak Temperature (Tp)	20-40 seconds
Ramp-Down Rate	6 °C/second max.
Time 25°C to Peak Temperature	8 minutes max

#### 8.4. Soldering gun procedure

Note the follows, in case of using solder gun for replacement.

- (1) The tip temperature must be less than 280°C for the period within 3 seconds by using soldering gun under 30 W.
- (2) The soldering gun tip shall not touch this product directly.

#### 8.5. Soldering volume

Note that excess of soldering volume will easily get crack the body of this product.

#### 8.6. Taping Package Storage Condition

Storage Temperature : 5 to 40 °C

Relative Humidity: < 65%RH

Storage Time : 12 months max